

Installation instructions for KZNG5-03009-00, KZNG5-03010-00
Under Run Protective Shield Engine Bay and Transmission Case

TOYOTA C-HR



LEXUS UX



Model year:

C-HR - 2018

UX - 2018

Applicability:

NGX10L-AHFDXX
NGX50L-AHXEXX
ZGX10L-AHXGPX

MZAA10L-AWXBBW
MZAH15L-AWXBBW

Part Number:

Steel: KZNG5-03009-00
Aluminium: KZNG5-03010-00
Installation kit: KZNG5-03009-60



Weight:

Steel: 9,78 kg
Aluminium: 7,08 kg



Installation Time:

30 min

Rev.3 29.08.2018

A

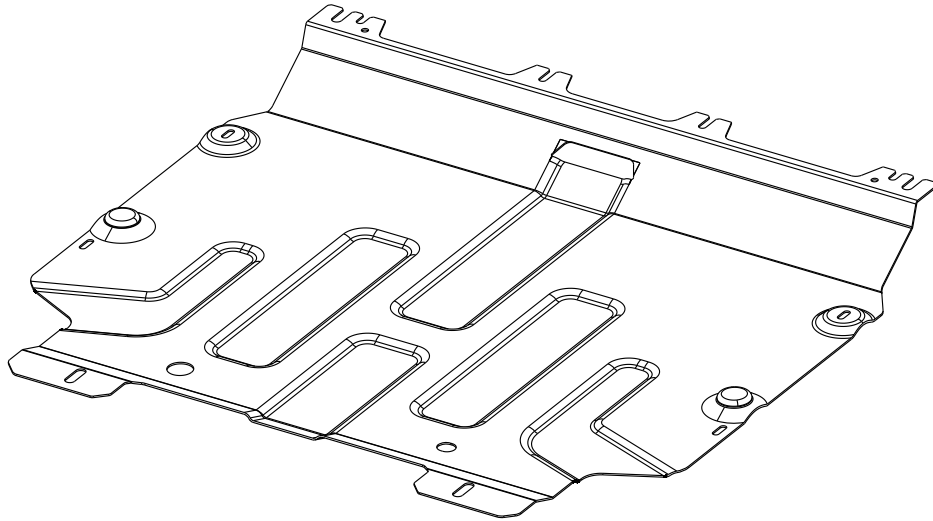

KZNG5-03009-60

B

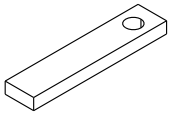

4x

C

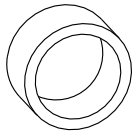

h=10 2x

D1

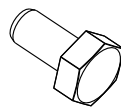

M6x30 4x

D2

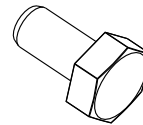

M8x20 2x

D3

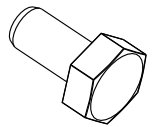

M8x30 2x

E1

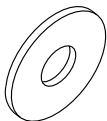

d=6

4x

E2

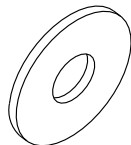

d=8

4x

F1



d=6

4x

F2



d=8

4x

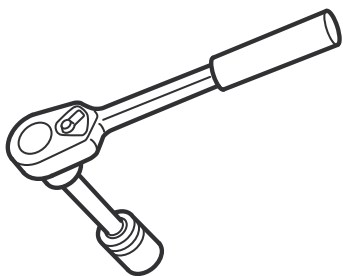

10 mm
13 mm

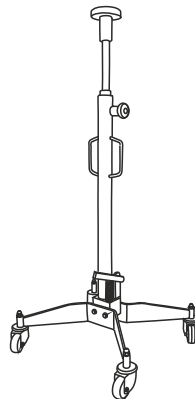

1

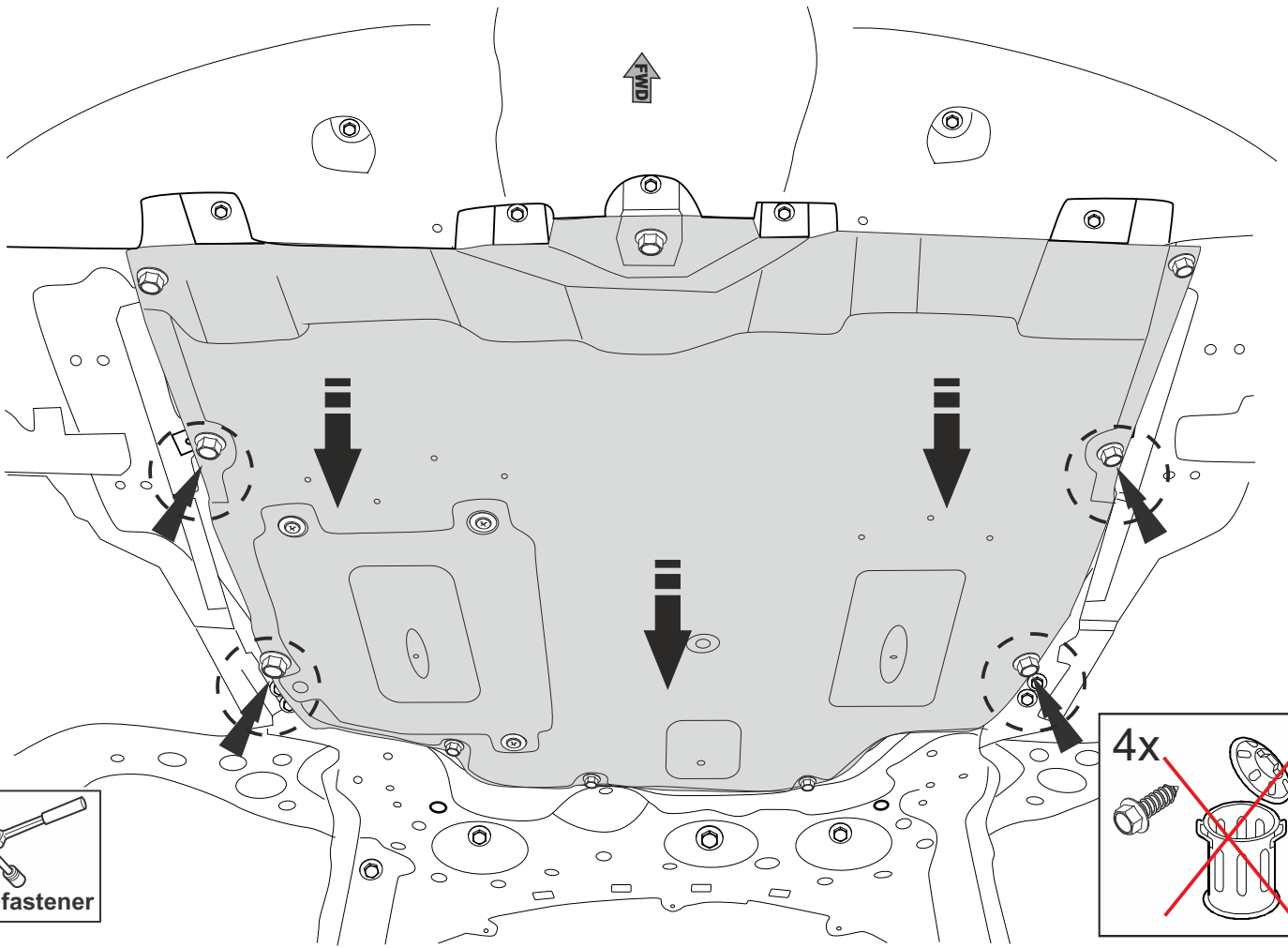

2

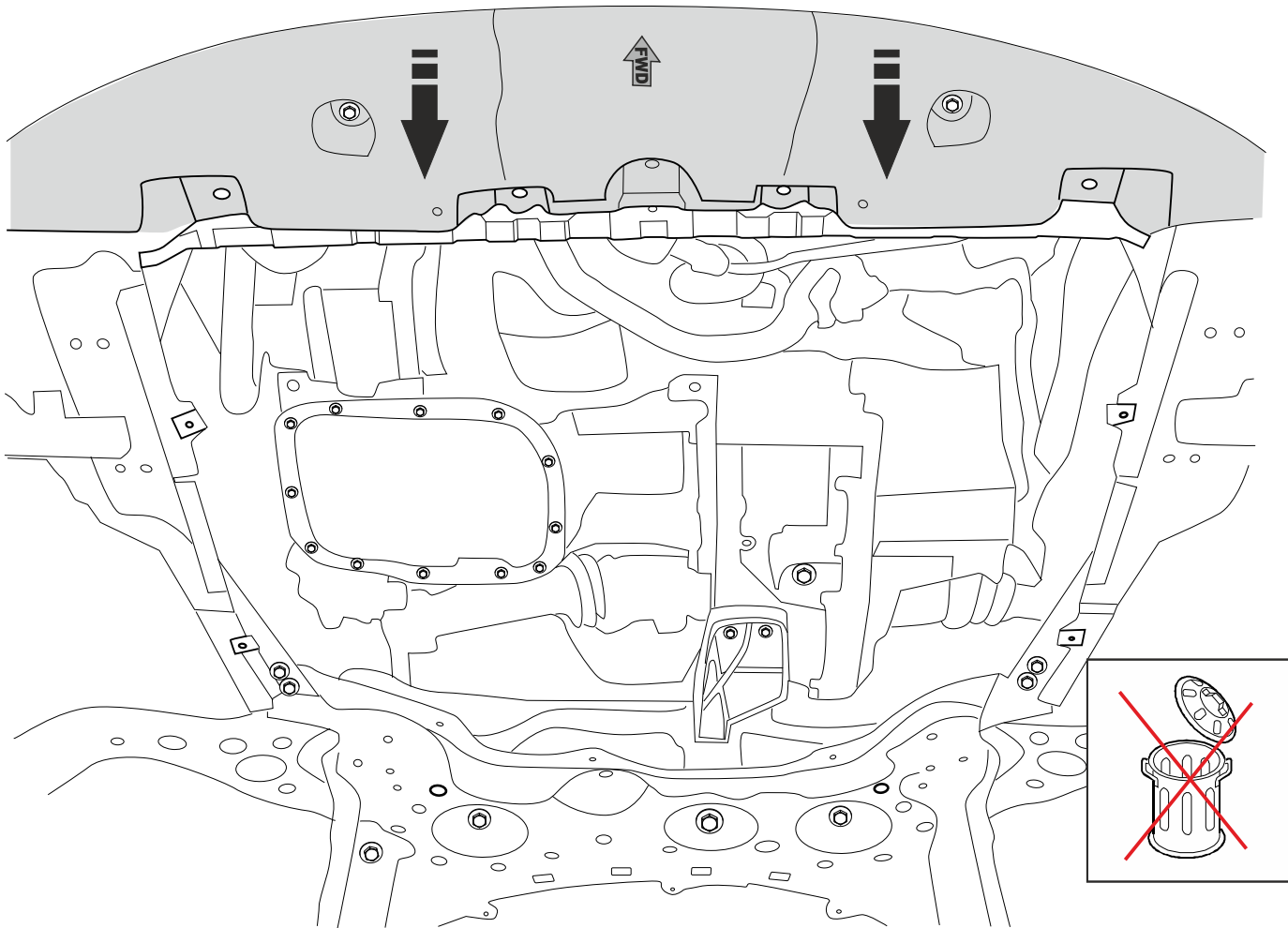

3

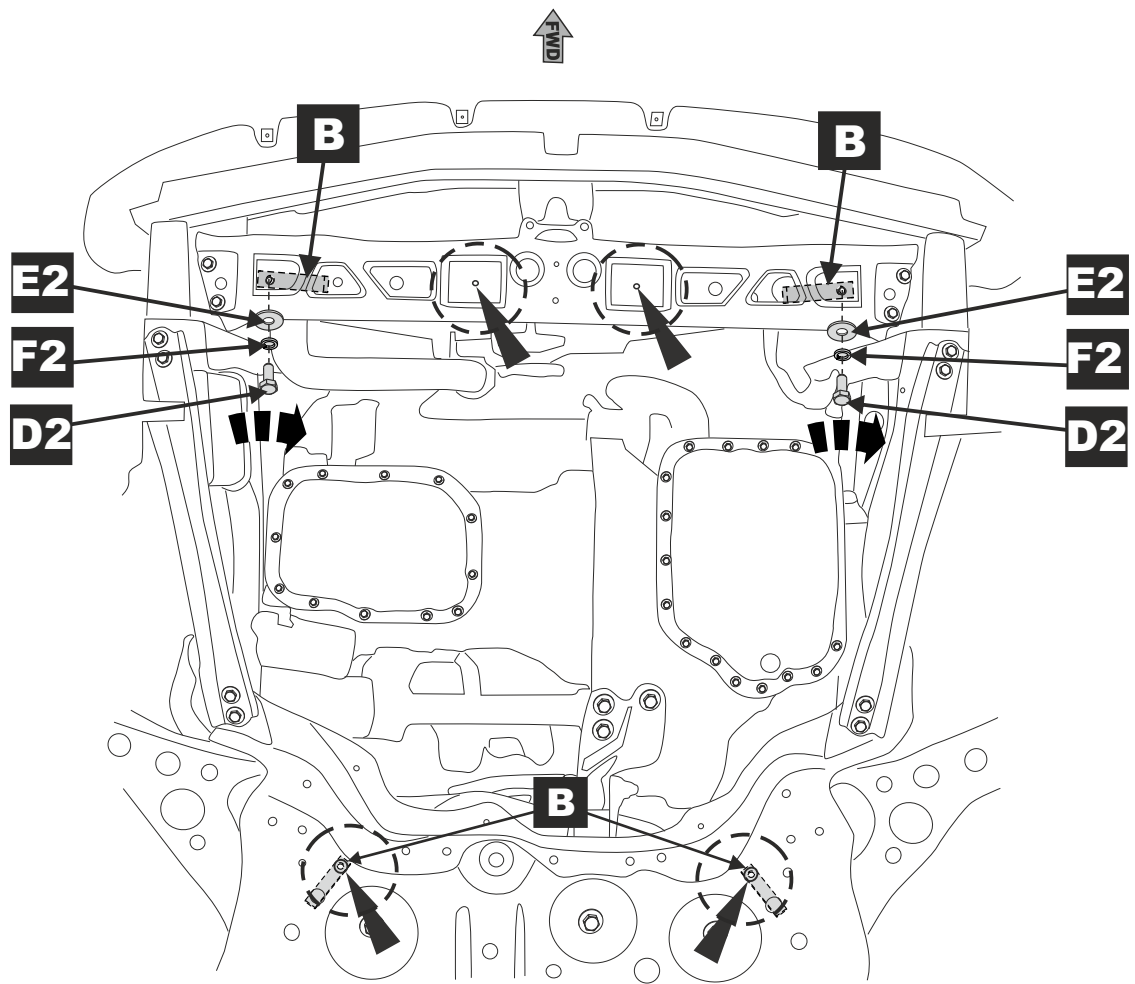

4

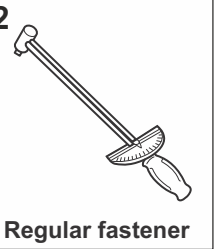
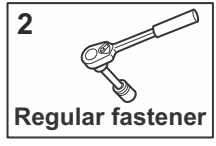
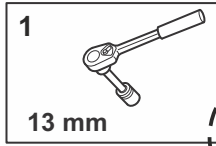
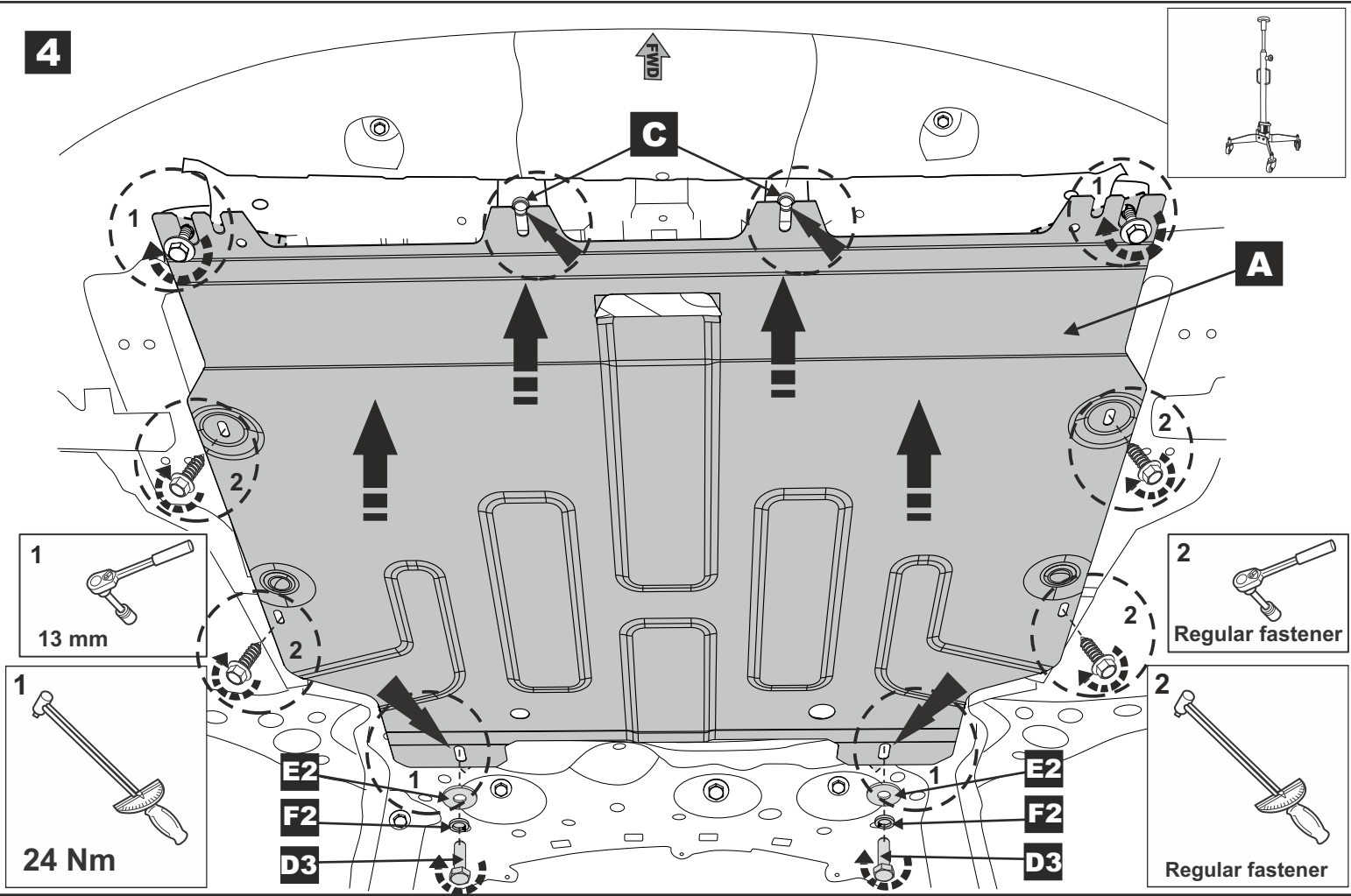

Part number:
KZNG5-03009-00
KZNG5-03010-00

Revision:
3

Date:
29.08.18

C-HR 2018
LEXUS UX 2018

Page:
4/5

5

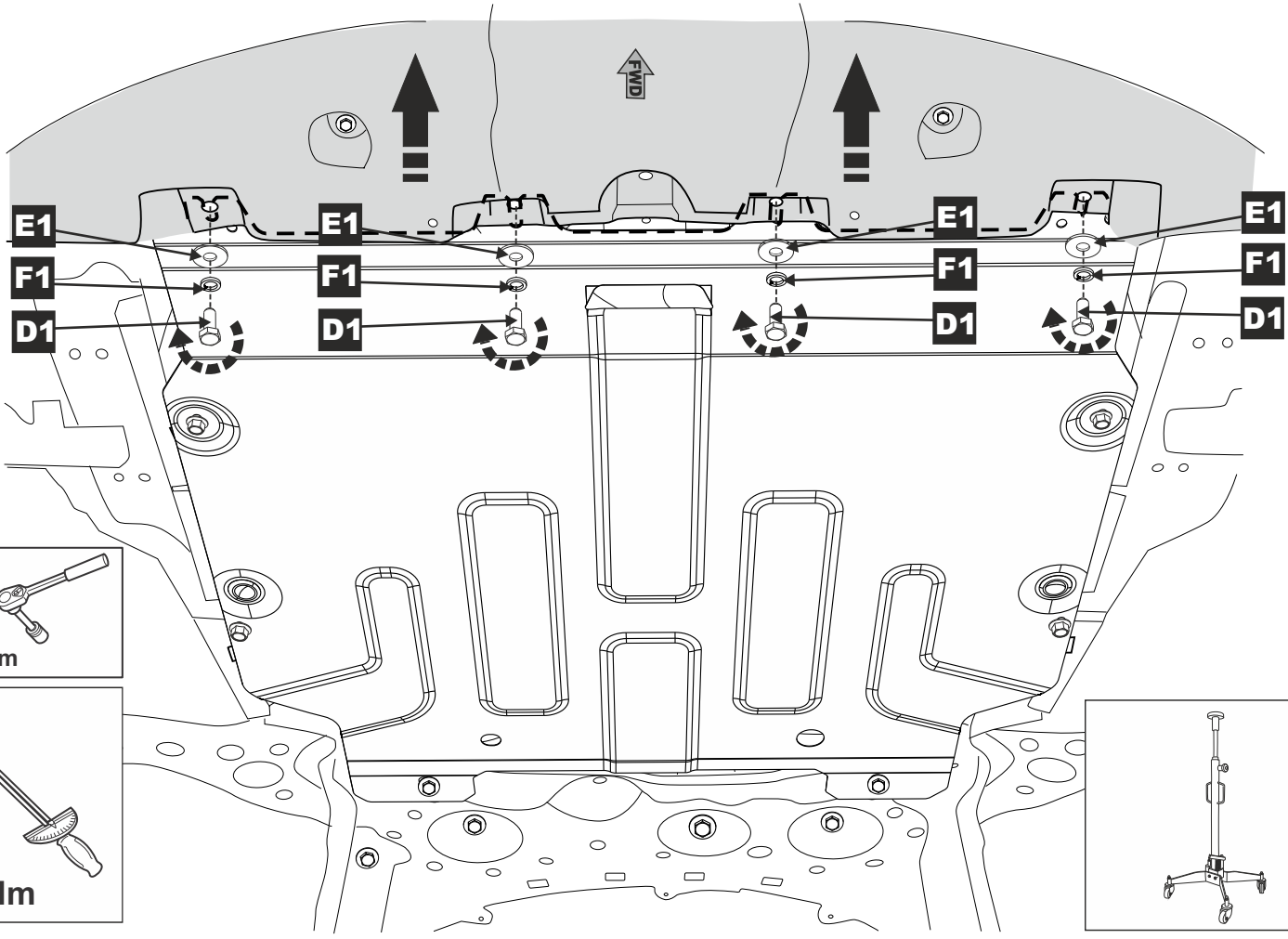

6

